

# 3 IN 1 VALETING MACHINE & VACUUM CLEANER

Model: **PC320.V2**

Issue:- 1  
Date Issued:- 27/01/04

Item	Part No.	Description
1	186.80015BNN	Feeder
2	186/50036ZON	Cable sleeve
3	186.50127BNN	Lever for tank hooking
4	186.50126BNA	Mask
5	186/50070BHA	Cover, motor
6	186/50104BHU	Diaphragm
6A	186/70055BON	Gasket, motor middle
7	186/70060B8N	Gasket, motor upper
8	186/20036BOX	Motor 1000watt (A227)
9	186/83020BHI	Silencer, motor
10	186/60325BHN	Connector
11	186.60231BHN	Plastic tube 150mm long
12	186.60327BHN	Cap for tank
13	186/83030BHI	Filter, pump pick-up
14	186.60225BHN	Plastic tube 190mm long
15	186/50183BOV	Protection grille
16	186/70032BON	Motor gasket, lower
17	186/50077BOV	Float
18	186.50179BNS	Motor sport
19	186.70122BHX	Silent block
20	186/01017BOU	Bin clip
21	186.50192BFA	Container
22	186.50125BHA	Trolley
23	186.30082BOX	Castor wheel
24	186/50118BHU	Handle
25	186/80041BDN	Switch, black bipolar
25A	186/80043BOE	Switch, illuminated bipolar
26	186/50073BHU	Motor cover, upper (SO)
27	186/50182B8N	Grip, cable - replaces 186/50482B8M
28	186/80299BHU	Pump (EP7)
29	186/70120BHN	Support, pump front
29A	186/70121BHN	Support, pump rear
30	186/50078ZOX	Cable grip
31	186/60300BHN	Elbow connection, pump
32	186/60307BHN	Quick connection
33	186/60234BHN	Plastic tube 220mm
34	186/60301BHN	T-piece - modification kit
35	186/25130BHG	Clamp
36	186/60227BHN	Tube, plastic 45mm
37	186/83021B8X	Filter, air vent
38	186/50170B8A	Grille, air outlet
39	186/80025B8X	Condenser (SO)
40	186/80102BHV	Connection series
41	186/50210BFA	Connection, air inlet
42	186.60212BHX	Liquid detergent tank
43	186.80051B5X	Brush holder insert
44	186/60235BHN	Plastic tube 110mm x 6mm diameter
45	186.70200BON	Plastic under handle
46	186/70011BON	Lid seal
47	186.60021BSN	Shock-proof band

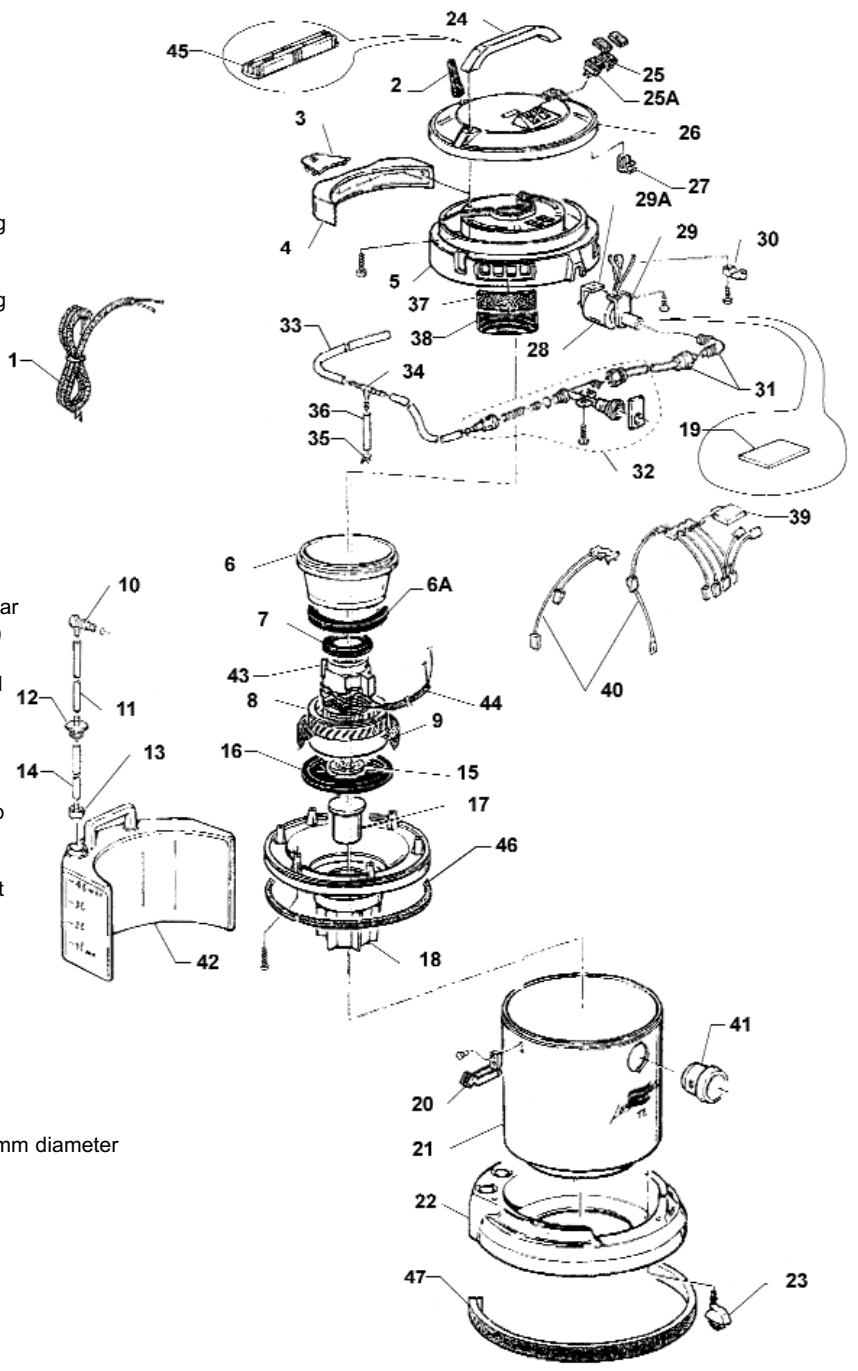

**3 IN 1 VALETING MACHINE & VACUUM CLEANER**

Model: **PC320.V2**

Issue:- 1  
Date Issued:- 27/01/04

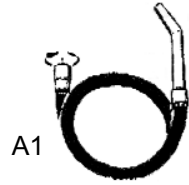

A1

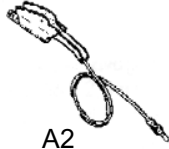

A2



A3



A4



A5



A6



A7

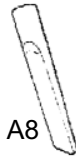

A8



A9



A11



A12



A13

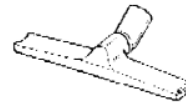

A14

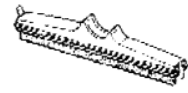

A15



A16

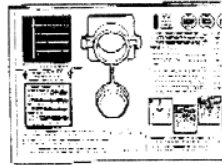

A18

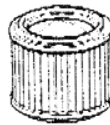

A19



A20



A21

Item	Part No.	Description
A1	186/01300BON	Hose complete 36mm x 2m
A2	186/01333BHN	Pistol system, detergent (trigger & tube)
A3	186/01330BHN	Upholstery tool complete 36mm
A4	186/01331BHN	Carpet tool assembly 36mm
A5	186/50372BHN	Adaptor, large nozzle 36mm
A6	186/30094BSX	Bristle strip
A7	186/70071BHN	Carpet tool rubber (pair)
A8	186/60250BON	Crevice tool 36mm
A9	186/60255BON	Round brush
A11	186/40023BOX	Aluminium extension tube
A12	186.60257BON	Upholstery nozzle
A13	186/95001FON	Large vacuum nozzle 36mm
A14	186/60281BON	Multi-purpose frame 36mm
A15	186/60278BON	Liquids adaptor
A16	186/50318BHN	Tube lock nut
A18	186/83140BOK	Dust collection bags (packet of 5)
A19	186/83200BOG	Cartridge filter
A20	VAC92/250/DL	Cartridge filter
A21	186/83035BHB	Foam filter