

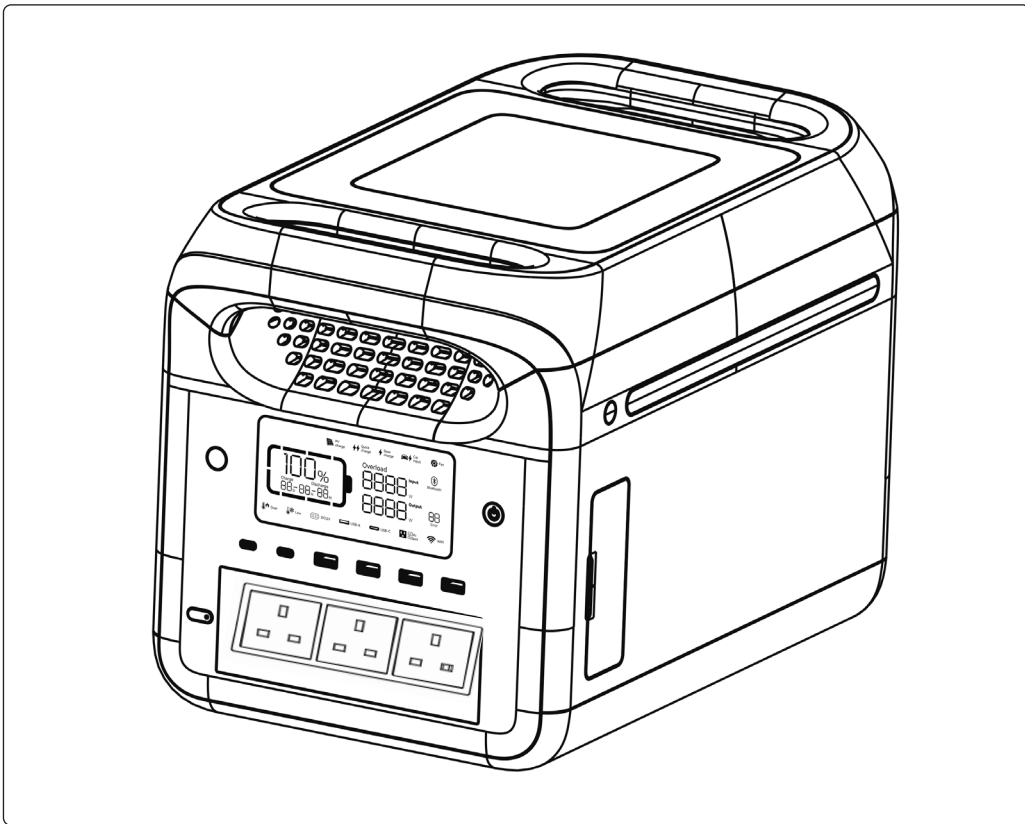

---

## Portable Power Station, 1800W, 1226Wh, LiFePO4 Battery, 230V



### Model No. DL162

Thank you for purchasing a Dellonda product. Manufactured to a high standard, this product will, if used according to these instructions, and properly maintained, give you years of trouble free performance.

## Important Information

Please read these instructions carefully. Note the safe operational requirements, warnings & cautions. Use the product correctly and with care for the purpose for which it is intended. Failure to do so may cause damage and/or personal injury and will invalidate the warranty. Keep these instructions safe for future use.



Refer to instruction manual



**DO NOT** cover



Warning: Electricity



Keep in dry area. Protect from rain.

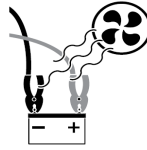

When charging vehicle battery, use in a well ventilated area and keep away from sources of ignition. Wear eye protection and protective gloves.



Warning: Electromagnetic fields

## Specification

Battery Capacity / Type	51.2V  24Ah (1226Wh) Lithium Phosphate (LiFeP04)
Discharge (Charge) temp range	20 - 45°C (0 - 45°C)
AC Input Voltage	230V ~ 50Hz, 10A, 1800W max.
Solar /Car Input	13 - 45V  12A, 400W max.
AC socket (x3) Inverter mode (Bypass mode)	230V ~ 50Hz, 13A, 1800W max.(230V ~ 50Hz, 13A, 1800W max.)
USB - A1/A2	5V  3A, 9v  2A, 12V  1.5A, 18W max.
USB - C1/C2	5/9/12/15V  3A, 20V  5A, 100W max..
USB - A3/A4	5V  2.4A, 12W max.
Car Charger Output	12.6 10A, 126W max.
DC 5521 (x2)	12.6 3A, 40.8Wmax.
IP Rating	IP20
Electrical Class:	Class I
Capacity:	1226Wh
Charge Time:	1hr 35mins.
Fuse Rating:	13A
Nett Weight:	19.18kg
Plug Type:	3-Pin BS
Wattage:	1800W

### • SAFETY INSTRUCTIONS

#### • ELECTRICAL SAFETY

• **WARNING!** It is the user's responsibility to check the following:

- Check all electrical equipment and appliances to ensure that they are safe before using.
- Inspect power supply leads, plugs and all electrical connections for wear and damage.
- Ensure that the insulation on all cables and on the appliance is safe before connecting it to the power supply.
- **DO NOT** use worn or damaged cables, plugs or connectors.
- Ensure that any faulty item is repaired or is replaced immediately by a qualified electrician.
- If the cable or plug is damaged during use, switch off the electricity supply and remove from use. If the supply cord is damaged, it must be replaced by the manufacturer, its service agent or similarly qualified persons in order to avoid a hazard.
- Dellonda recommend that an **RCD** (Residual Current Device) is used with all electrical products.
- Important: Ensure that the voltage rating on the appliance suits the power supply to be used and that the plug is fitted with the correct fuse.
- **DO NOT** pull or carry the appliance by the power cable.
- **DO NOT** pull the plug from the socket by the cable.
- The power station must not be located under an electrical socket; the socket must always be accessible in order to disconnect the power station from the electrical supply for maintenance and cleaning.

#### • GENERAL SAFETY

- **IMPORTANT:** Read all instructions and warnings carefully before starting installation. Failure to follow these instructions may result in a possible electric shock or fire hazard and will void the warranty.
- Children from age 8 years and above, persons with reduced physical, sensory, or mental capabilities those with lack of experience and knowledge can use the appliance, if they have been given supervision or instruction concerning use of the appliance in a safe way to understand the hazards involved.
- Children shall NOT play with the appliance.
- Cleaning and user maintenance on the appliance shall not be made by children without supervision.
- Children of less than 3 years should be kept away unless continuously supervised. Children aged from 3 years and less than 8 years shall only switch on/off the appliance provided that it has been placed or installed in its intended normal operating position and they have been given supervision or instruction concerning use of the appliance in a safe way and understand the hazards involved. Children aged from 3 years and

- less than 8 years shall not plug in, regulate, and clean the appliance or perform user maintenance.
- The disconnection of the plug has to be such that an operator can check from any of the points to which he / she has access that the plug remains removed.
- DO NOT** attempt to repair, disassemble or modify the appliance. This unit contains no user-serviceable parts.
- Always unplug or disconnect the appliance from the mains power supply when not in use, or when moving or cleaning it.
- Keep the unit clean. **DO NOT** allow any object to enter or cover the ventilation openings as this may cause electric shock, fire, or damage to the power station.
- DO NOT** use the appliance for anything other than its intended use.
- Avoid the use of an extension cable, as the cord may overheat and cause a risk of fire.
- This appliance is designed for indoor use only and is not intended for use in bathrooms, laundry areas and similar indoor locations. Never locate this appliance where it may become exposed to water or a damp environment. Ensure the cord is kept away from traffic areas, and kept in a position which would not present a trip hazard.
- To disconnect this appliance, turn off mains power and press and hold the On/Off button to turn off, then remove the plug from the outlet.
- DO NOT** let a working power station be close to any heat source, such as a fire or heater.
- DO NOT** allow the power station to come into contact with any liquid.
- DO NOT** use power station in a strong electrostatic or strong magnetic field environment.
- DO NOT** disassemble power station in any way or pierce it with a sharp object.
- DO NOT** short the power station by wire or other metal objects.
- It is forbidden to step on, sit or climb on this product.
- DO NOT** use non-genuine parts or accessories. For part or accessory replacement contact your Sealey stockist.
- When using power station, please follow the operating temperature defined in this user manual. If the temperature is too high, battery may catch fire or even explode. If the temperature is too low, power station performance will be seriously impaired, even normal use will be impacted.
- Please **DO NOT** put other heavy objects on the power supply except the expansion battery pack. The stacking method of the expansion battery pack has been designed and tested by structural mechanics. **DO NOT** stop the fan by force or expose power station in an unventilated or dusty environment when it is working.
- Please avoid collision, dropping, and violent vibration of the power station. If an impact happens, shut down the power supply immediately. Please fix power station firmly during transportation to avoid vibration and impact.
- If power station falls into water accidentally, place it in a safe and wide area, and keep yourself away from it until it's dry. Dried product shall not be used again. Dispose of it properly according to local regulations and this manual.
- If power station is on fire, please use fire extinguishing equipment in the recommended order: water or water mist, sand, fire blanket, dry powder, carbon dioxide fire extinguisher.
- If the power station is dirty or dusty, use a dry cloth to wipe it clean.
- Place power station carefully in a safe area to prevent any possible damage.
- If power station is tipped over and seriously damaged, turn off power station immediately and place the battery in a spacious ventilated place and keep it away from flammable materials and people. Scrap it in accordance with the requirements of local laws and regulations.
- Keep power station out of the reach of children and pets.
- Keep power station in a dry and ventilated place.
- In humid environments (i.e. seaside, water, etc.), it is recommended to equip power station with moisture-proof bag.
- If water is found inside product, **DO NOT** use/start it again. Please take countermeasures to prevent electric shock before touching power station. Put it in a safe and waterproof open area, and contact customer service immediately.
- It is not recommended to use power station to supply power for safety-related emergency medical equipment, including but not limited to medical grade breathing machine (hospital version **CPAP**: Continuous Positive Airway Pressure), artificial lung (**ECMO**, Extracorporeal Membrane Oxygenation). It can be used to supply power for home version **CPAP** at home and does not require continuous professional monitoring. Please follow your doctor's advice and consult the manufacturer for any restrictions on the use of the device. For general medical equipment, please pay attention to the power condition to ensure that power does not run out.
- Power supplies will inevitably generate electromagnetic fields when it is in use, which might affect the implantable medical device or normal operation of personal medical device, such as pacemaker devices, cochlear implants, hearing aids, defibrillators, etc. If any of these medical devices are used, please consult the manufacturer about the restrictions on the use to ensure that power station is operated at a safe distance from implanted medical devices such as pacemakers, cochlear implants, hearing aids, defibrillators, etc.
- When the power station is connected to a refrigerator, it may automatically shut down because of the power fluctuation property of the refrigerator. When connecting the power supply to a refrigerator that stores medicine, vaccines or other valuable items, it is recommended to set the **AC** output to "Never off" in the **APP**, so as to ensure continuous power. Users should pay attention to power consumption.

### • Manual Handling (fig.1)

- The power station must not be moved while in use. Please allow a suitable amount of time for the unit to cool before attempting to move it.
- DO NOT** tip the power station.
- It is recommended that a minimum of two people are required to lift the power station.
- Two anti-slip gloves (supplied) can be wrapped in the front and rear handles to prevent slipping.

### • Contents (fig.1)

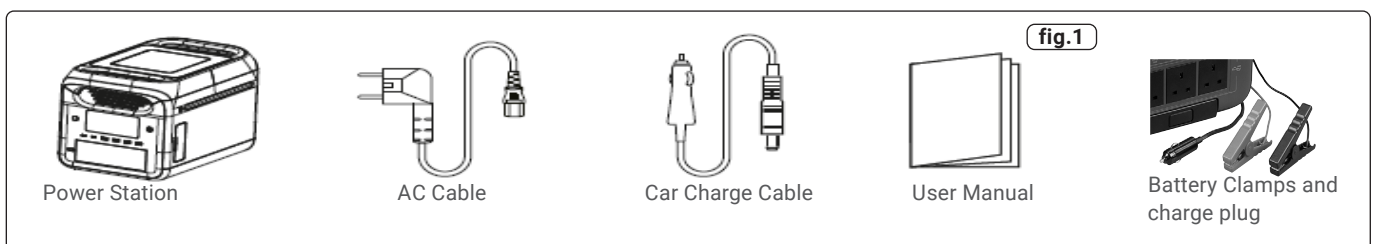

### • Installation

- This product is designed to be used on a dry, clean, flat, even surface capable of securely holding its weight.

### • Operation (fig.2, fig.3, fig.4)

- See App section for wifi operation plus QR .
- The bypass function causes the unit to bypass the battery when plugged into mains supply. Should the mains have an outage, the battery cuts in.

- Press the main power switch (fig.2.2) to turn on the device, then the screen will be lit and the main power indicator light will light up.
  - When this product has not been interacted with for 5 minutes without any operation, the LCD display (fig.2) will be automatically extinguished.
  - When this product is plugged in and unplugged from mains, pv, car charger or key operation, the LCD display will be lit up automatically. To turn the LCD display on or off, press the display control button (fig.3.8).
  - Press and hold the main power switch will turn off power station.
  - In the normal mode (the power is above 5%), the default standby time of this product is 2 hours.
  - When the AC output switch is not turned on, and there is no charge or discharge for 2 hours, the product will automatically shut down, and the standby time can be set using the App.
  - When the power is 5% or below, the product will be forced to enter the low power mode. In the case of no charge or discharge, the product will adjust the standby time according to the power and automatically shut down.
  - In normal mode, depress and hold the LED light button (fig.4.2) to exit the automatic shutdown setting, and the battery icon on the screen will flash.
  - Depress again to enter the automatic shutdown setting, and the battery icon does not flash. The automatic shutdown setting is to protect the battery from low power, exiting this setting may damage the battery life, please use it with caution.
  - It is recommended to use or store power station 20 to 30°C ambient temperature.
- **AC OUTPUT** (fig.3, fig.4)
    - After ensuring that the main power is turned on, depress the AC output power switch (fig.3.6) to turn on the AC output. Depress the AC output power switch again to turn it off.
    - The default standby time of the AC output port is 1 hour. After 1 hour without any load on the AC output port of this product, the AC output power will be automatically turned off.
    - In normal mode, depress and hold the LED light button (fig.4.2), the AC output power switch can exit the automatic shutdown setting, and the battery icon on the screen will flash. Depress and hold again and the AC output power switch enters the automatic shutdown setting, and the battery icon does not flash.
    - Depress and hold the LED light button to exit the AC automatic shutdown setting. It is applicable to AC equipment below 10W and pulse working equipment.
    - When the AC output is not in use, turn it off (fig.3.6) to save power consumption.
  - **DC OUTPUT** (fig.4)
    - After the main power switch is turned on, press the 12V DC output power switch (fig.4.5) to enable the DC output port.
    - Press the 12V DC output power switch again to turn it off.
  - **AC CHARGING** (fig.5)
    - Please use the AC charging cable provided for fast charging. AC charging cable should directly plug into a 10A (or above) wall-mounted socket.
    - Quick charging technology is designed for AC charging. You can control the charging power via the AC charging speed switch (fig.5).
    - The slow charge mode is on by default when power station is turned on, and can be switched to quick charge mode by the button (fig.5).
    - Although unavailable in the UK, If the current is continuously higher than 20A, the charging input port will start the self-protection function, and the charging overload protection switch (fig.5) will automatically trip. Press the charge overload protection switch to restore charging after confirming no fault codes present.
  - **SOLAR PANEL CHARGING** (fig.5)
    - Please follow the Solar Panel user manual to connect the solar panels.
    - Before connecting solar panels (fig.5.3), check whether panels output voltage is within power station specifications to avoid damage to power station.
    - The interface of this product is DC7909.
  - **CHARGING POWER STATION FROM VEHICLE** (fig.5)
    - Power station can be charged by the car charging port (fig.5.3) and the vehicles auxiliary power socket. It should be charged after the car is started to avoid the car battery loss and failure to start.
    - Ensure there is a good connection between the car charging port and the vehicles auxiliary power socket.
  - **EPS FUNCTION**
    - This product supports the EPS (emergency backup power) function.
    - Connect the power grid and the AC input port of this product through the AC charging cable.
    - Bypass mode (AC power comes from the grid, not the battery); when the grid suddenly loses power, the product can automatically switch to battery power supply mode within 010mS, at this time it is an inverter mode (AC power comes from the battery, not the grid).
    - This function does not support 0mS switching. Please do not connect it to devices that require high uninterrupted power supply, such as data servers and workstations, or use it after multiple tests to confirm whether it is compatible. It is recommended to use only one device during use, and do not use multiple devices at the same time to avoid overload protection of the product.
    - If the device does not operate normally or data is lost due to failure to follow the instructions, our company will not bear the corresponding responsibility.
  - **CAR BATTERY CHARGING**
  - **BATTERY CHARGING SAFETY INSTRUCTIONS**
    - Familiarise yourself with the application and limitations of the charger as well as the potential hazards. Also refer to the vehicle manufacturer's hand book. **IF IN ANY DOUBT CONSULT A QUALIFIED ELECTRICIAN.**
    - Ensure the charger is disconnected from the mains supply before attaching/detaching the power clamps to/from the battery.
    - Ensure the output of the charger is the same voltage as the battery.
    - Ensure that during charging, the charger is placed in a location where there is sufficient ventilation to prevent the build up of explosive gases from a lead acid battery, and **DO NOT** cover or obstruct the charger ventilation louvres.
    - If battery has caps to access the battery fluid, remove the caps and check the fluid level before connecting the power clamps.
    - If necessary top-up the battery with distilled water by referring to the battery manufacturer's instructions. Apply the personal safety precautions described in part 1.3.
    - If the battery terminals are corroded or dirty clean them before attaching the power clamps.
    - Keep children and unauthorised persons away from the working area.
    - Ensure there is effective ventilation to prevent a build-up of explosive gases, and **DO NOT** cover or obstruct charger ventilation louvres.

- **WARNING!** To prevent the risk of sparking, short circuit and possible explosion **DO NOT** drop metal tools in the battery area, or allow them to touch the battery terminals.
- **DO NOT** try to charge a non-rechargeable battery.
- **DO NOT** try to charge battery if battery fluid is frozen.
- **DO NOT** allow power clamps to touch each other or to make contact with any metallic part of the vehicle.
- **DO NOT** cross connect power leads from charger to battery. Ensure positive (+/**RED**) is to positive terminal and negative (-/**BLACK**) is to negative terminal.
- **DO NOT** pull the cables or clamps from the battery terminals.
- **DO NOT** use the charger outdoors, or in damp, or wet locations and **DO NOT** operate within the vicinity of flammable liquids or gases.
- **DO NOT** use the charger for a task for which it is not designed.

• **BATTERY CHARGING PROCESS** (fig.4)

- Remove the battery from the vehicle and place alongside the unit within reach of the terminal clamps. Ensure the battery is in a stable position.
- With the unit off insert the clamp cable plug into the car charge output connection (fig.4.8) and connect the clamps to the battery terminals connecting the red clamp to positive terminal and the black clamp to negative. Reverse this process when disconnecting.
- Power on the unit and then press the DC power button (fig.4.5). As the battery charges, the LED displays the power station output to the battery.

• **USE OF APP**

- You can control and view information and data about this product by App.
- Software download, search for [Smart Life] in the Google App Store or Apple App Store, download the software, register and open it or scan the QR code below to download.
- For detailed usage of the App, please refer to the App Operation Guide.



• **MAINTENANCE**

- **WARNING!** Before cleaning the appliance, the power supply should be disconnected and the unit should be allowed to cool.
- For long-term storage, charge and discharge every 3 months, i.e. discharge to 0% then charge to 100%.
- For safety, **DO NOT** store power station with temperature above 45°C or below -10°C.
- If the capacity is lower than 1%, please charge to 60%. Long-term storage with serious power shortage will cause irreversible damage to the cell and shorten the service life of the product.
- If the capacity is seriously insufficient and idle time is too long, the product will enter deep sleep mode, and the product can only be used after being charged.
- After charging or discharging this product, you must wait for more than 30 minutes before using it.
- Dust can be removed by lightly wiping surfaces with clean, lint free cloth or paper towel.
- **DO NOT** use abrasive cleaner.
- **DO NOT** spray liquids directly onto any surface of the unit.

• **SERVICING**

- It is hazardous for anyone, other than a qualified service technician, to carry out any service or repair operation, which involves removal of any components.

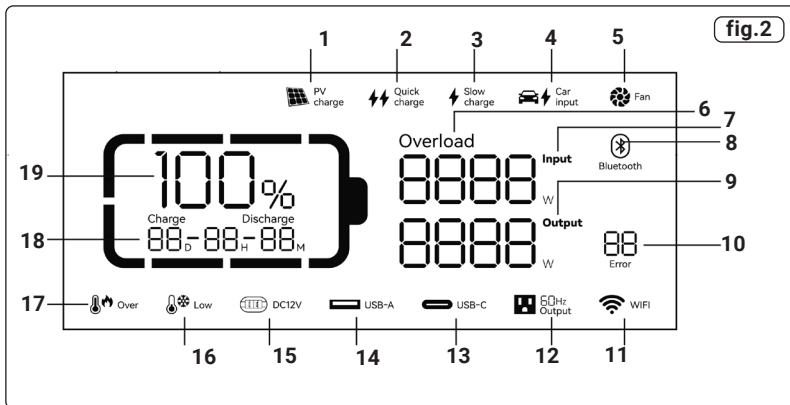

Figure 2 Key	
Item	Description
1	PV charge
2	Quick charge
3	Slow charge
4	Car charge
5	Fan status
6	Overload
7	Input power
8	Bluetooth
9	Output power
10	Error code
11	Wi-Fi connection status
12	AC output
13	USB-C output
14	USB-A output
15	DC output
16	Low temperature warning
17	Over temperature warning
18	Remaining charge / discharge time
19	Remaining battery percentage

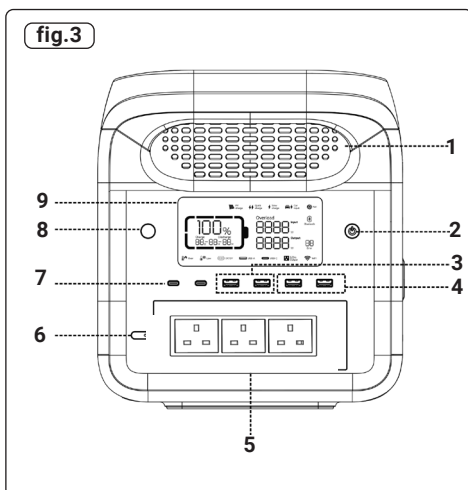

Figure 3 Key	
Item	Description
1	Ventilation opening
2	ON/OFF button
3	USB-A quick charge output x2
4	USB-A output port x2
5	AC output sockets
6	AC output button
7	USB-C output port x2
8	LCD button
9	LCD

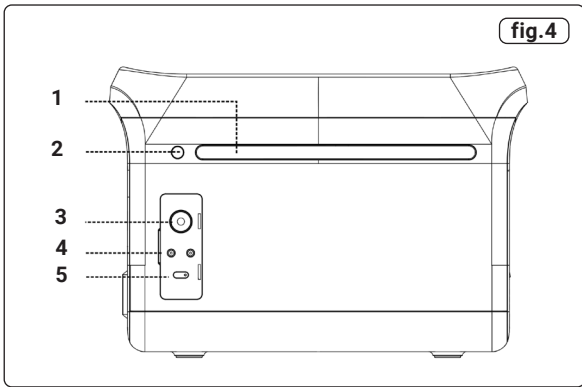

fig.4

Figure 4 Key	
Item	Description
1	LED light
2	LED light button
3	Car charge output
4	DC5521 plug x2
5	DC output ON/OFF

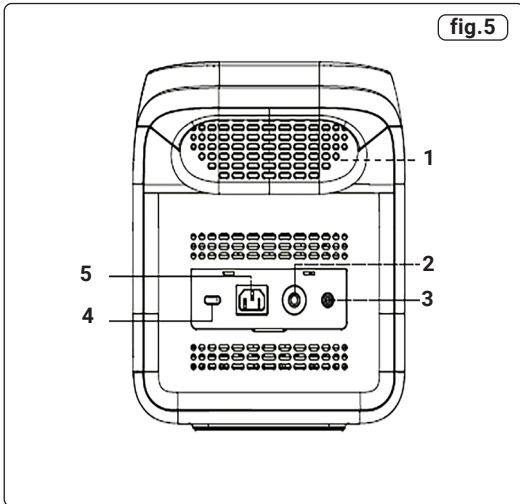













fig.5

Figure 5 Key	
Item	Description
1	Ventilation opening
2	Overload protection switch
3	Solar / car charge input
4	Quick charge / slow charge switch
5	AC input socket

## • Troubleshooting

- If a warning occurs during the use of this product, and the warning icon still does not disappear after restarting the device, please stop using it immediately and seek qualified technical advise. **DO NOT** try to use, charge or discharge the station in this situation.

	01 Error	Error code always on	Serious battery fault	Turn on and off, contact after sales if still not fixed.
	02 Error	Error code always on	Battery cell voltage difference fault	Auto shutdown, fault will be cleared after reboot.
	03 Error	Error code always on	BMS voltage fault	
	04 Error	High temperature icon flickers Error code always on	Battery OTP (over temperature protection) fault	Auto shutdown, temperature recovery enables starting up.
	05 Error	Low temperature icon flickers Error code always on	Battery UTP (under temperature protection) fault	
	06 Error	Error code always on	Overcurrent/short circuit fault	Auto shutdown, fault will be cleared after reboot.
	07 Error	High temperature icon flickers Error code always on	BMS board over temperature fault	Auto shutdown, delayed start.
	08 Error	Error code always on	Pre-charge fault	Auto shutdown, fault will be cleared after reboot.
	09 Error	Error code always on	Battery under voltage fault	Auto shutdown and charge, contact after sales if still not fixed after multiple charging failures.
	10 Error	Error code always on	Abnormal parallelization	Check the connection cable. Contact after sales if still not fixed. Single power station function is not affected.
	11 Error	Error code always on	Abnormal INV battery voltage	Auto recover after fault is cleared.
	12 Error	Error code always on	Grid voltage or frequency fault	The fault is cleared when the grid returns to normal.
	13 Error	Error code always on	Abnormal INV BUS voltage	Auto recover after fault is cleared.
	14 Error	Error code always on	Abnormal INV output	
	15 Error	Overload icon always on Error code always on	INV discharge overload	Remove over-power device. Auto recover after fault is cleared.
	16 Error	Overload icon always on Error code always on	Charge overload	Auto recover after fault is cleared.
	17 Error	Error code always on	INV Tz	
	18 Error	Error code always on	INV input short	Fault will be cleared after reboot.
	19 Error	Error code always on	INV output short	
	20 Error	High temperature icon flickers Error code always on	MOSFET OTP fault	Auto recover after product is cooled down.
	21 Error	Error code always on	Fan stop	Turn on and off, contact after sales if still not fixed.
	22 Error	Error code always on	Discharge soft start fault	Auto recover after fault is cleared.
	23 Error	Error code always on	Charge soft start fault	
	24 Error	Low temperature icon flickers Error code always on	MOSFET UTP fault	Turn on and off, contact after sales if still not fixed.
	25 Error	Error code always on	Anderson hardware OCP fault	Remove PV charge, auto recover after connecting PV and turn on.
	26 Error	Error code always on	Anderson software OCP fault	Turn off output, manual recover after fault is cleared.
	27 Error	Error code always on	PV hardware OCP fault	Remove PV charge, auto recover after connecting PV and turn on.
	28 Error	Error code always on	PV1 software OCP fault	Stop PV1 charging, auto recover after connecting PV and turn on.
	29 Error	Error code always on	PV2 software OCP fault	Stop PV2 charging, auto recover after connecting PV and turn on.
	30 Error	Error code always on	Car charger output/ DC5521 output Over current protection	Turn off output, manual recover after fault is cleared.

 31 Error	Error code always on	PV output OVP (over voltage protection) fault	Stop PV. Auto recover after fault is cleared.
 32 Error	Error code always on	PV1 input OVP fault	Stop PV1. Auto recover after fault is cleared.
 33 Error	Error code always on	PV2 input OVP fault	Stop PV2. Auto recover after fault is cleared.
 Over 34 Error	High temperature icon flickers Error code always on	Anderson OTP fault	Turn off output, manual recover after fault is cleared.
 Over 35 Error	High temperature icon flickers Error code always on	PV1 OTP fault	Stop PV1. Auto recover after fault is cleared.
 Over 36 Error	High temperature icon flickers Error code always on	PV2 OTP fault	Stop PV2. Auto recover after fault is cleared.
 Over 37 Error	High temperature icon flickers Error code always on	Car charge output OTP fault	Turn off output, manual recover after fault is cleared.
 38 Error	Error code always on	Abnormal communication	Turn on and off, or change operation environment. Contact after sales if still not fixed.
 USB-A 39 Error	USB icon flickers Error code always on	Abnormal USB	Auto recover after removing abnormal USB.
 USB-C 40 Error	Type C icon flickers Error code always on	Abnormal type C	Auto recover after removing abnormal type C.
 43 Error	Error code always on	The battery voltage is too low. The battery is broken	Contact after-sales processing.



## Environment Protection, Waste Electrical and Waste Electronic Equipment Regulations (WEEE)



Recycle unwanted packaging materials. When this product is no longer required, or has reached the end of its useful life, please dispose of in an environmentally friendly way. Drain any fluids (if applicable) into approved containers, in accordance with local waste regulations. It is our policy to continually improve products and we reserve the right to alter data, specifications and parts without prior notice. No liability is accepted for incorrect use of this product. Guarantee is 12 months from purchase date, proof of which is required for any claim.

## Dellonda Limited, Sole UK Distributor of Baridi

Kempson Way, Suffolk Business Park, Bury St Edmunds, Suffolk. IP32 7AR



01284 757575



support@dellonda.co.uk



www.dellonda.co.uk