



**INFLATABLE STAND UP PADDLE BOARDS WITH LEASH,
PUMP & CARRY BAG**



Model No: DL152 & DL153

Thank you for purchasing a Dellonda product. Manufactured to a high standard, this product will, if used according to these instructions, and properly maintained, give you years of trouble free performance.



IMPORTANT INFORMATION

Please read these instructions carefully. Note the safe operational requirements, warnings & cautions. Use the product correctly and with care for the purpose for which it is intended. Failure to do so may cause damage and/or personal injury and will invalidate the warranty. Keep these instructions safe for future use.

SAFETY

READ THESE INSTRUCTIONS IN FULL BEFORE USE.



ATTENTION! Tighten the air valve before first use and before reuse after long breaks.



WARNING! DO NOT leave the paddle board exposed under direct sunlight. This will shorten the life of product.



WARNING! A Personal Flotation Device (PFD) is required for each user.



WARNING! Beware of offshore winds and currents. **DO NOT** use in high wind, open water!



WARNING! DO NOT dive or jump from the paddle board.



WARNING! DO NOT use the paddle board around sharp objects.



WARNING! Keep away from fire.

- Keep away from fire.
- This is not a life saving device. Use only under competent supervision.
- Never allow diving/jumping into this product.
- Never leave in or near the water when not in use.
- Never tow from any vehicle.
- Adult assembly and operation required.
- Excessive inflation of the paddle board can cause the chamber to burst or cause damage to the welded seams.
- Take a paddle boarding safety course or get hands-on training from an approved provider.
- Review all safety requirements regularly.
- Never navigate alone.
- A Personal Flotation Device (PFD) is required for each user.
- It is especially important that children and non-swimmers wear a Personal Flotation Device at all times.
- Children and non-swimmers need additional special instruction in the use of SUP.
- Care should be taken when stepping or climbing onto the paddle board.
- Distribute the weight evenly so that the paddle board sits even front to back and each side.
- **DO NOT** use your paddle board if you suspect a puncture or an air leak. It might be unsafe and is dangerous.
- **WARNING!** Beware of offshore winds and under-currents.
- **WARNING!** It is the responsibility of the paddle board operator to identify and obey all local and state laws pertaining to paddle board safety and equipment. Consult your local authorities to ensure compliance.
- **WARNING! DO NOT** dive or jump from board.
- **DO NOT** allow unattended children on the paddle board.
- Always make sure that at least one responsible adult is supervising all children and those who don't know how to swim at all times.
- Always maintain the proper paddle board safety equipment in an easily accessible place.
- Indicate clearly emergency phone numbers and safety advisories and rules (such as "No Jumping or Diving").
- The total weight on board shall not exceed the information printed on the paddle board.
- **DO NOT** exceed the maximum recommended capacities. Overloading violates regulations, and is dangerous.
- **DO NOT** place the Paddle board against or near any open flames, heaters, furnaces or other hot objects.
- **WARNING!** Children must not be left unattended when using the paddle board. Use only under adult competent supervision.
- **WARNING! DO NOT** leave product exposed under sunlight directly because it will shorten the life of the product.
- Children shall not play with the paddle board.
- Keep pets away from paddle board. Pets may tear or puncture the paddle board.
- **NOTE:** Follow these rules to avoid drowning, paralysis or other serious injuries.

WATERWAYS

Managed waterways in England and Wales, such as some rivers and canals require a licence to be able to paddle on them. This license can be purchased from the British Canoeing website and costs around £45 per year (2023). A portion of that license fee goes towards the upkeep and maintenance of those waterways. If your board is shorter than 3.5 metres long, it is classed as recreational beach gear. Under that category, you are permitted to paddle anywhere in the sea but must stay within 300 metres of the shore.

SPECIFICATION

MODEL NO:	DL152	DL153
Accessories:	Pump, Carry Bag, Leash, Paddle, Valuables/Puncture Repair Kit Container	
Boat/Board Type:	SUP	SUP
Colour:	Light Blue/White	Blue/White
Dimensions (W x D x H):	3200*840*150mm	3100*790*150mm
Length (SUP):	10'6"	10'2"
Maximum Weight:	330lb / 150kg	298lb / 140kg
Nett Weight (Board):	8.03kg	8.3kg
Nett Weight (Board + Accessories):	11.28kg	11.4kg
PSI:	12-15psi	12-15psi
Volume:	332L	308L

PREPARATION

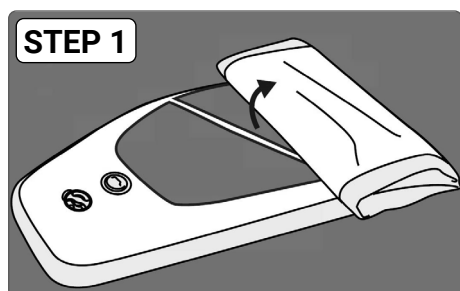

1. Unroll the paddle board on a flat surface, away from sharp objects such as stones. Ensure the valve is facing up.

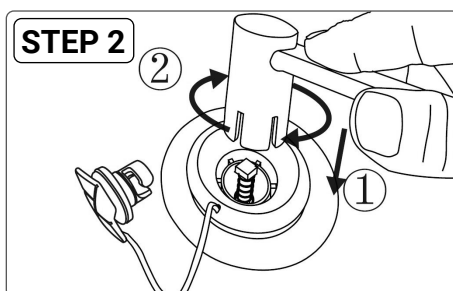

2. Ensure the valve and cap are fully secure using the tool provided.

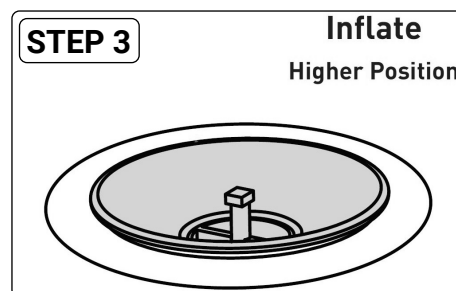

3. To inflate the paddle board, ensure the valve is in the higher position.

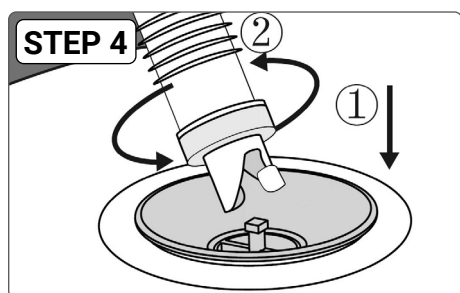

4. Remove the valve cover and insert the pump provided (push and twist).

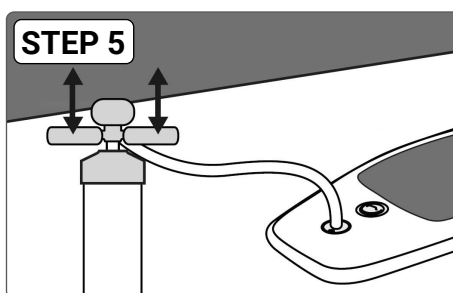

5. Pump the paddle board up to a pressure of 12-15PSI. Replace valve cap.

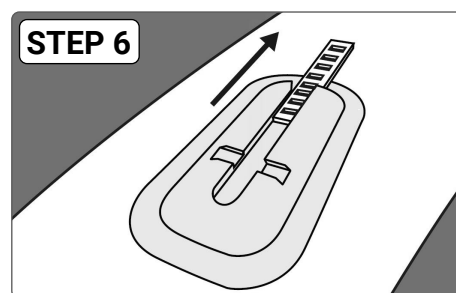

6. Remove the plastic insert and store in bag for future use.

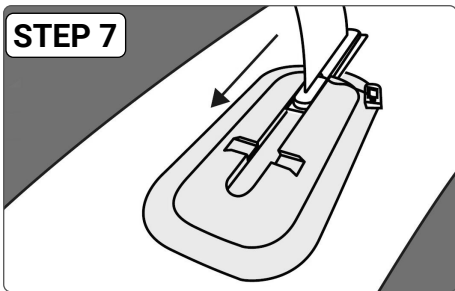

STEP 7

7. Insert the fin so the leading edge faces the front of the paddle board.

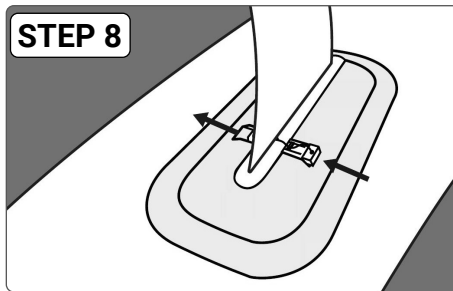

STEP 8

8. Secure the fin to the paddle board using the clip. 'Click' into place.

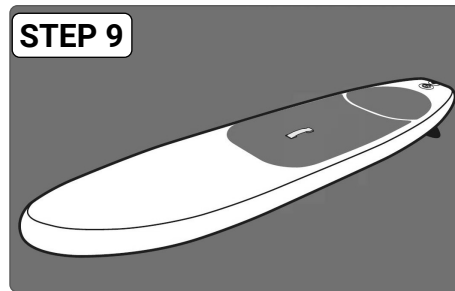

STEP 9

9. The paddle board is ready for use.

REMEMBER TO USE THE LEASH: The primary purpose of a paddleboard leash is to keep your board close to you while paddling, ensuring your safety and preventing it from getting lost or damaged. It serves this purpose by attaching to your leg or ankle and the board, keeping the two connected.

NOTE: the dual action pump works when the cap is closed. This means air will be expelled when you lift the handle up or push it down. When you remove the cap, the pump becomes single action. This means air will only be expelled when you push the handle down. The dual-action is useful to quickly fill the paddleboard with air. As the pressure increases, switch to single action to reach the required pressure (12-15PSI).



PADDLE

Assemble the paddle as shown below. Ensure the spring-loaded button secures the shaft of the paddle. The lock lever can be used to adjust the length to suit the user. For general paddling, the paddle length should be 6-8 inches above the head of the paddler. This can be tweaked according to individual needs.



DEFLATING

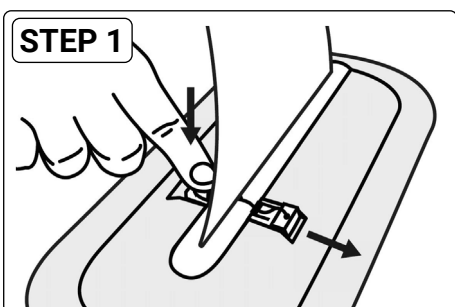

STEP 1

1. Push the fin clip down and slide out.

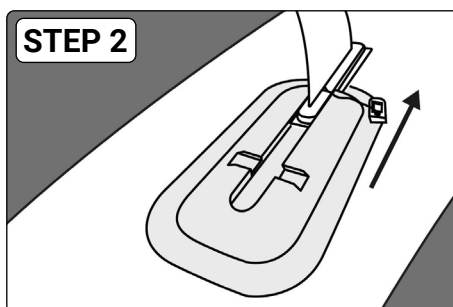

STEP 2

2. Remove the fin from the paddle board. Replace with the plastic insert.

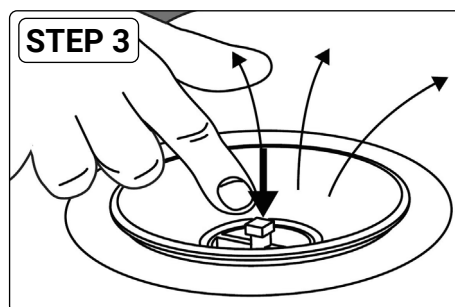

STEP 3

3. Push the valve down to deflate the paddle board.

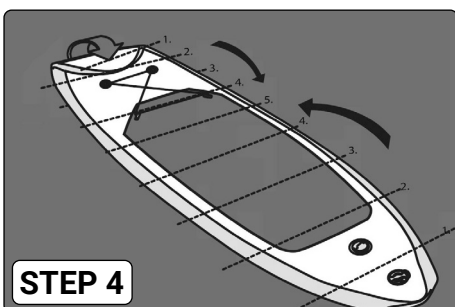

STEP 4

4. Fold the paddle board as shown above.

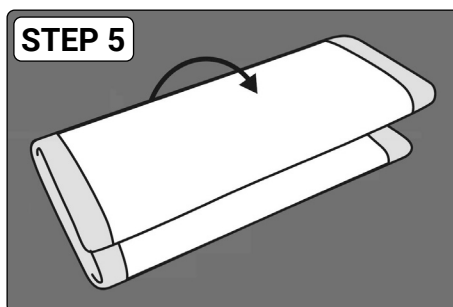

STEP 5

5. Once folded, store the paddle board in its original bag.

IMPORTANT:
Clean your paddle board after a trip to prevent damage from sand, salt water or sun exposure.

VALVE

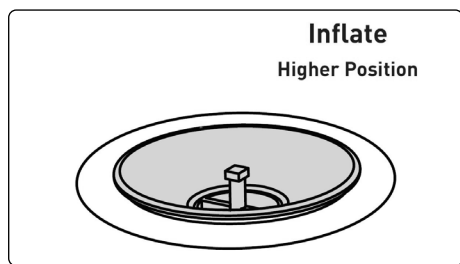

To inflate the paddle board, ensure the valve is in the higher position.

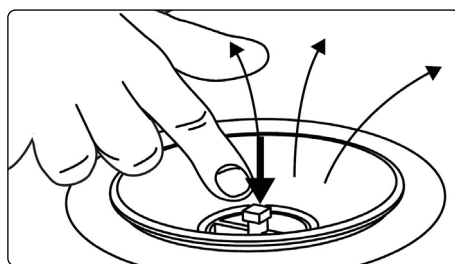

To deflate the paddle board, ensure the valve is in the lower position.



The Schrader valve (supplied) can be used with a range of pumps to inflate the paddle board.

VALVE REPLACEMENT

To replace a broken or leaky valve, follow the steps below.

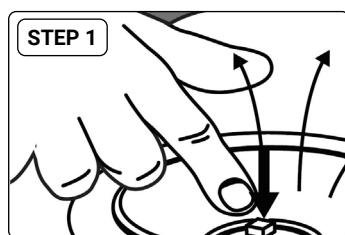

1. Deflate the paddle board.

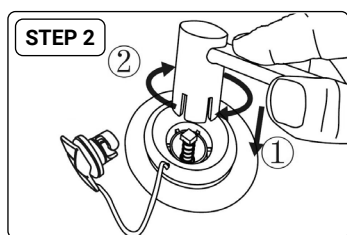

2. Using the tool provided, remove the valve.

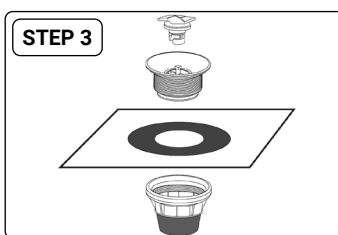

3. Assemble the new valve as shown above.

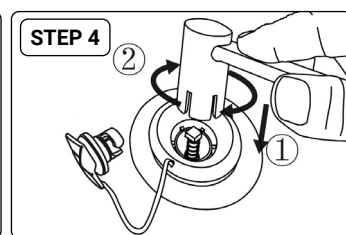

4. Secure the new valve with the tool provided.

PUNCTURE REPAIR

The Repair Kit includes glue and PVC sheet. The Repair Kit can be used only if the leak is below 10mm diameter.



1. Wipe the hull with soap and water to find holes in the SUP. The soap will bubble over the hole.



2. Clean the area around the hole with water or alcohol.

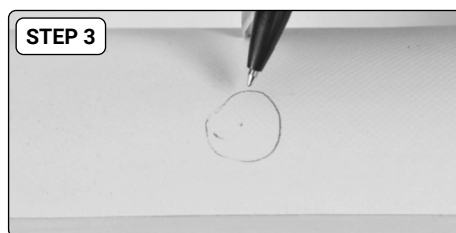

3. Use a pencil to sketch out the outline of the patch.

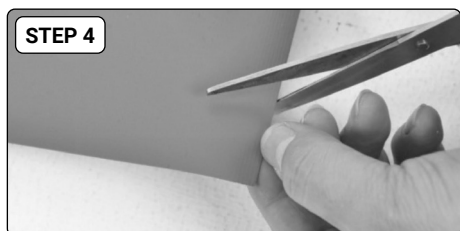

4. Cut a patch of suitable size.

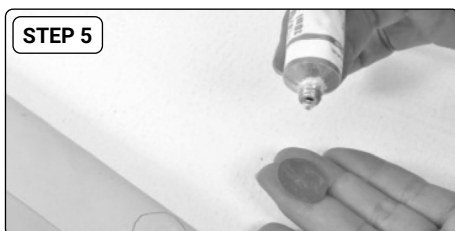

5. Apply glue (not supplied) evenly to the damaged area and patch. Press and hold the patch on the damaged area.



6. Leave the paddle board for at least 24 hours or more before inflating.

ENVIRONMENT PROTECTION AND WASTE PROTECTION

Recycle unwanted packaging materials. When this product is no longer required, or has reached the end of its useful life, please dispose of it in an environmentally friendly way. Drain any fluids (if applicable) into approved containers, in accordance with local waste regulations. It is our policy to continually improve products and we reserve the right to alter data, specifications and parts without prior notice. No liability is accepted for incorrect use of this product. Guarantee is 12 months from purchase date, proof of which is required for any claim.

Dellonda Limited

Kempson Way, Suffolk Business Park, Bury St Edmunds, Suffolk. IP32 7AR



01284 757575



support@dellonda.co.uk



www.dellonda.co.uk