



---

## Rattan Outdoor Dining/Bistro Table with Tempered Glass Top



### **Model No. DG65**

Thank you for purchasing a Dellonda product. Manufactured to a high standard, this product will, if used according to these instructions, and properly maintained, give you years of trouble free performance.

## Important Information

Please read these instructions carefully. Note the safe operational requirements, warnings & cautions. Use the product correctly and with care for the purpose for which it is intended. Failure to do so may cause damage and/or personal injury and will invalidate the warranty. Keep these instructions safe for future use.



Refer to  
instruction  
manual

## About the Product

Manufactured using premium quality PE weave rattan material. UV Treated, fade resistant and weatherproof design can be used outside all year round. Easy to clean 5mm clear tempered glass table top. Can be used as a side table, snack table or bistro table. Disclaimer: Colours may slightly vary due to lighting conditions. Material: Polyurethane Rattan.













### • SPECIFICATION

- Model no: ..... **DG65**
- Table dimensions (Ø x H): ..... Ø70 x 74cm
- Material: ..... Polyurethane Rattan

## Safety Instructions

- Always read these instructions fully before assembling and using your furniture.
- **WARNING!** Keep all flame and heat sources away from this furniture.
- **DO NOT** use bleach, alkaline or harsh detergents for cleaning. Soap and warm water are recommended.
- **DO NOT** use a high-pressure washer to clean this product.
- This product has a reasonable level of protection against **UV** degradation, however as with any material it will begin to fade and degrade after long periods of exposure to the sun.

## Contents

<b>A</b>	TABLE TOP		1	<b>B</b>	TABLE BASE LEGS		2	<b>C</b>	TABLE BASE INFILL PANELS		2
<b>D</b>	BOLT (M6X35)		8	<b>E</b>	BOLT (M6X20)		4	<b>F</b>	NUT (M6)		8
<b>G</b>	STEEL WASHER (M6)		20	<b>H</b>	PLASTIC WASHER		8	<b>I</b>	PLASTIC BOLT CAP (M6)		12
<b>J</b>	GLASS TOP		1	<b>K</b>	SPANNER		1	<b>L</b>	HEX KEY		1

## Assembly

- Carefully turn the table top (A) onto it's face and position the two legs (B) and bolt in place using the M6 x 20mm bolts (E) and M6 steel washers (G).

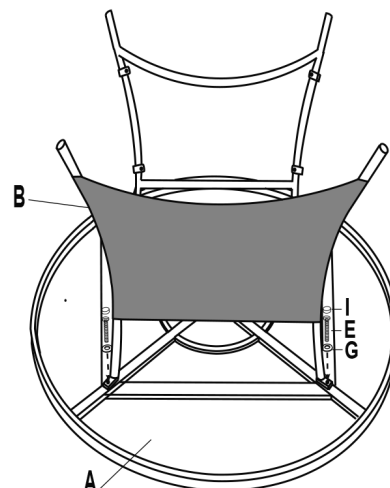

- Offer up the two table base infill panels (C) into the table base legs (B), using the shown nut a bolt sequence to secure, pass a steel washer (G) onto the M6 x 35mm bolt (D) then pass this through the two tabs trapping a plastic washer (H) in between, then push on another M6 steel washer (G) and secure with an M6 nut (F), cover the bolt head by pushing the plastic bolt cap (I).
- Repeat this sequence for the other seven connecting positions.
- It may be useful to only tighten the bolts for all eight locations at the end of the assembly sequence.

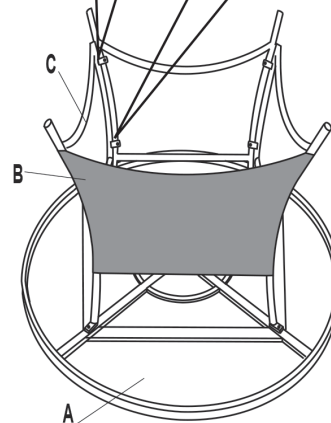
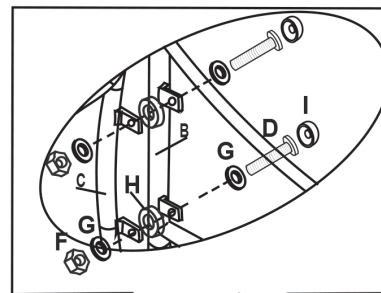

- Turn the table assembly onto its feet and carefully lift into position the glass table top (J).

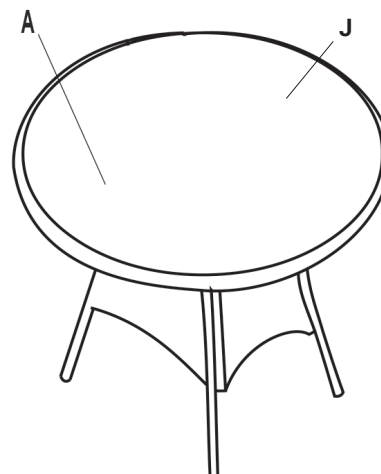

## STORAGE

- Ensure that the table is clean dry before being stored in a cool, dry and well ventilated location.
- Wipe down the table's frame and legs and any areas that could have been exposed to mud and dirt.
- Store the table during long periods of not being used prolong the usable life of all parts.

### Environment Protection and Waste Protection and Electrical Equipment Regulations (WEEE)

Recycle unwanted packaging materials. When this product is no longer required, or has reached the end of its useful life, please dispose of it in an environmentally friendly way. Drain any fluids (if applicable) into approved containers, in accordance with local waste regulations. It is our policy to continually improve products and we reserve the right to alter data, specifications and parts without prior notice. No liability is accepted for incorrect use of this product.

**Note:** It is our policy to continually improve products and as such we reserve the right to alter data, specifications and component parts without prior notice.

**Important:** No Liability is accepted for incorrect use of this product.

**Warranty:** Guarantee is 12 months from purchase date, proof of which is required for any claim.

## Dellonda Limited

Kempson Way, Suffolk Business Park, Bury St Edmunds, Suffolk. IP32 7AR

☎ 01284 757575

✉ support@dellonda.co.uk

🌐 www.dellonda.co.uk